



PHOTOFACT[®] with

CIRCUITRACE[®]



TRADE NAME : Volvo Model 7BVOX (1967 Volvo)
 SUPPLIER : For Current Address, See Annual Index
 TYPE SET : 6-Transistor Receiver
 POWER SUPPLY : 12 Volt Storage Battery
 RATING : .7 Amp @ 12.6 Volts DC

VOLVO MODEL 7BVOX

ALIGNMENT INSTRUCTIONS

Check for specified source voltage.
 Use only enough generator output to provide a usable indication.
 Suggested Alignment Tools:

A1 thru A7. GENERAL CEMENT: 9440
 WALSCO: 2501

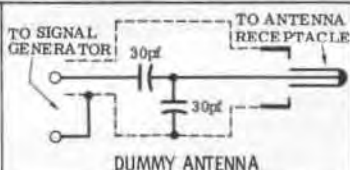

PUSH-BUTTON ADJUSTMENT

1. Pull button out.
2. Tune manually to desired station.
3. Press button in firmly.
4. Repeat for remaining buttons.

SIGNAL GENERATOR COUPLING	SIGNAL GENERATOR FREQUENCY	RADIO DIAL SETTING	INDICATOR	ADJUST	REMARKS
1. High side thru .1mfd to point Δ , low side to ground.	262.5KC (400% Mod.)	High freq. end stop.	Output meter across voice coil.	A1, A2, A3, A4	Adjust for maximum.
2. Thru dummy antenna to antenna receptacle.	1605KC	"	"	A5, A6, A7	"
Step 3 is not necessary unless tuner has been tampered with or associated components have been replaced. If necessary, back tuning cores (A8, A9, A10) out of coils but not out of forms. Repeat Step 2.					
3. Thru dummy antenna to antenna receptacle.	1000KC	Tune to signal.	Output meter across voice coil.	A8, A9, A10	Adjust for maximum. Repeat Steps 2 and 3 until no further improvement is noted.
With radio installed in car and antenna extended to desired height, tune in a weak station near 1400KC and adjust A7 for maximum output. Antenna adjustment (A7) is located on rear to the right of the antenna receptacle.					

HOWARD W. SAMS & CO., INC. Indianapolis, Indiana 46206

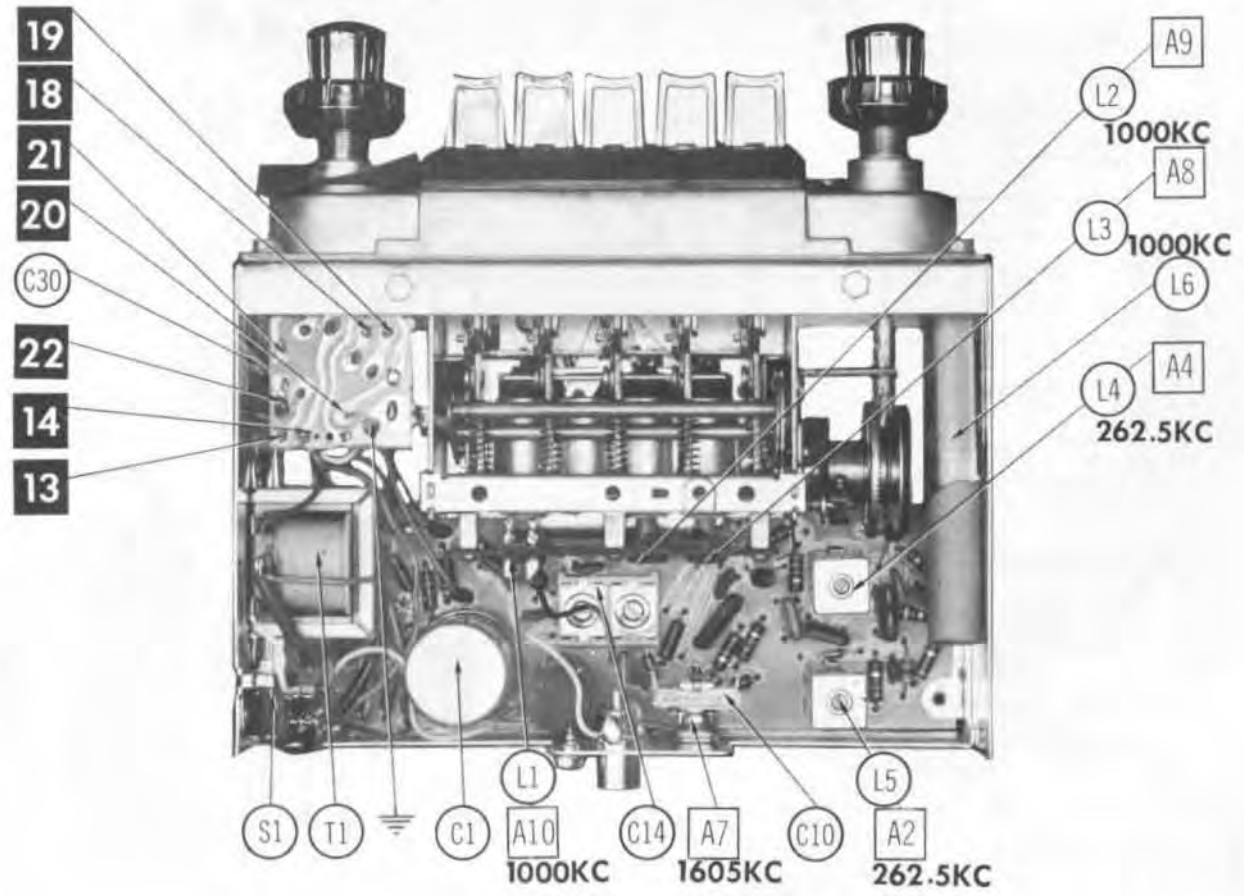
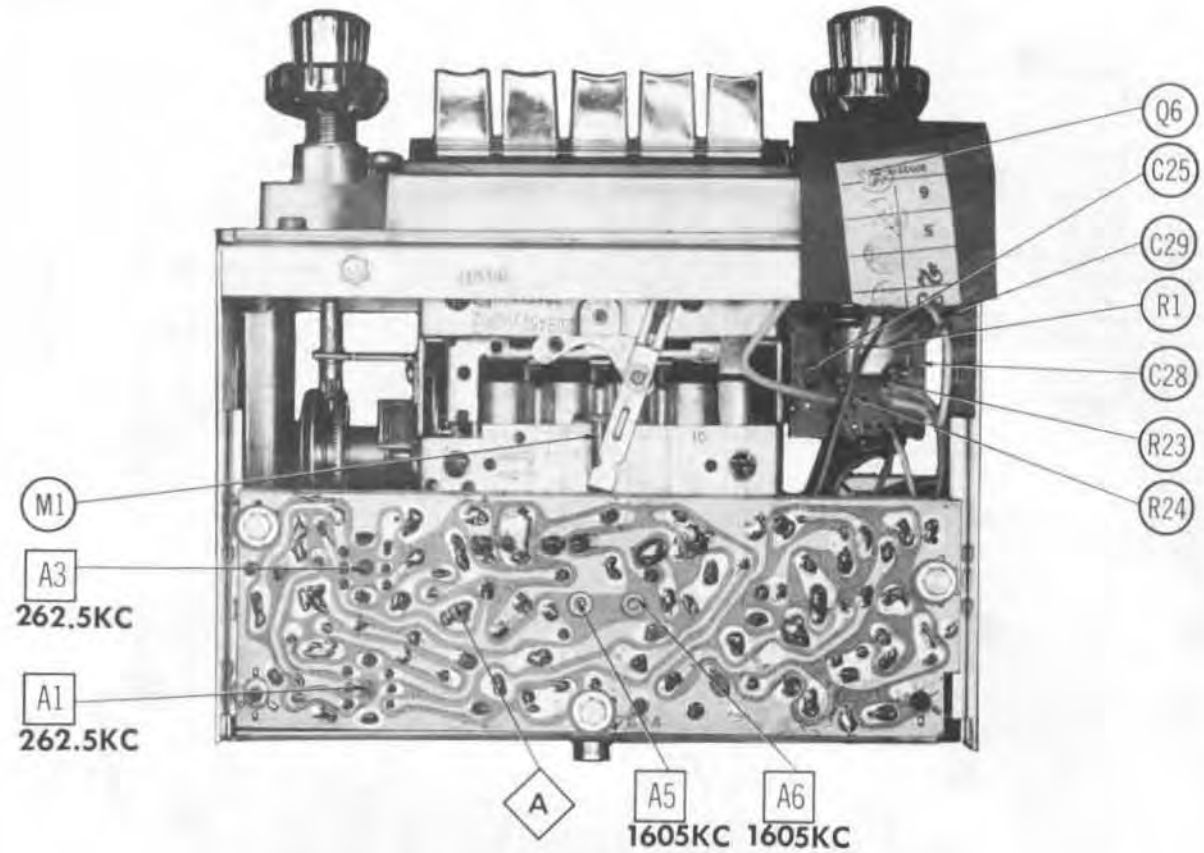

A Howard W. Sams CIRCUITRACE® Photo

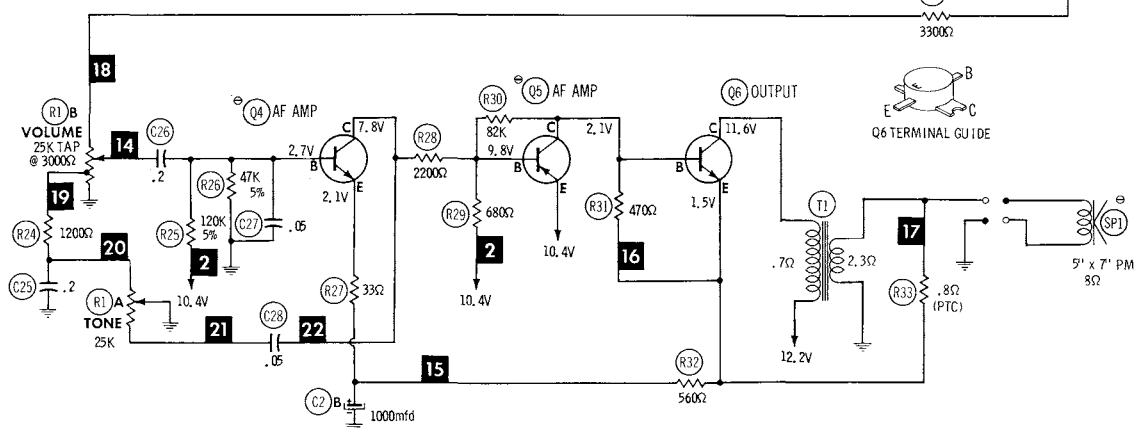
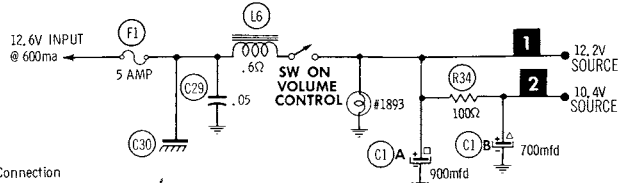
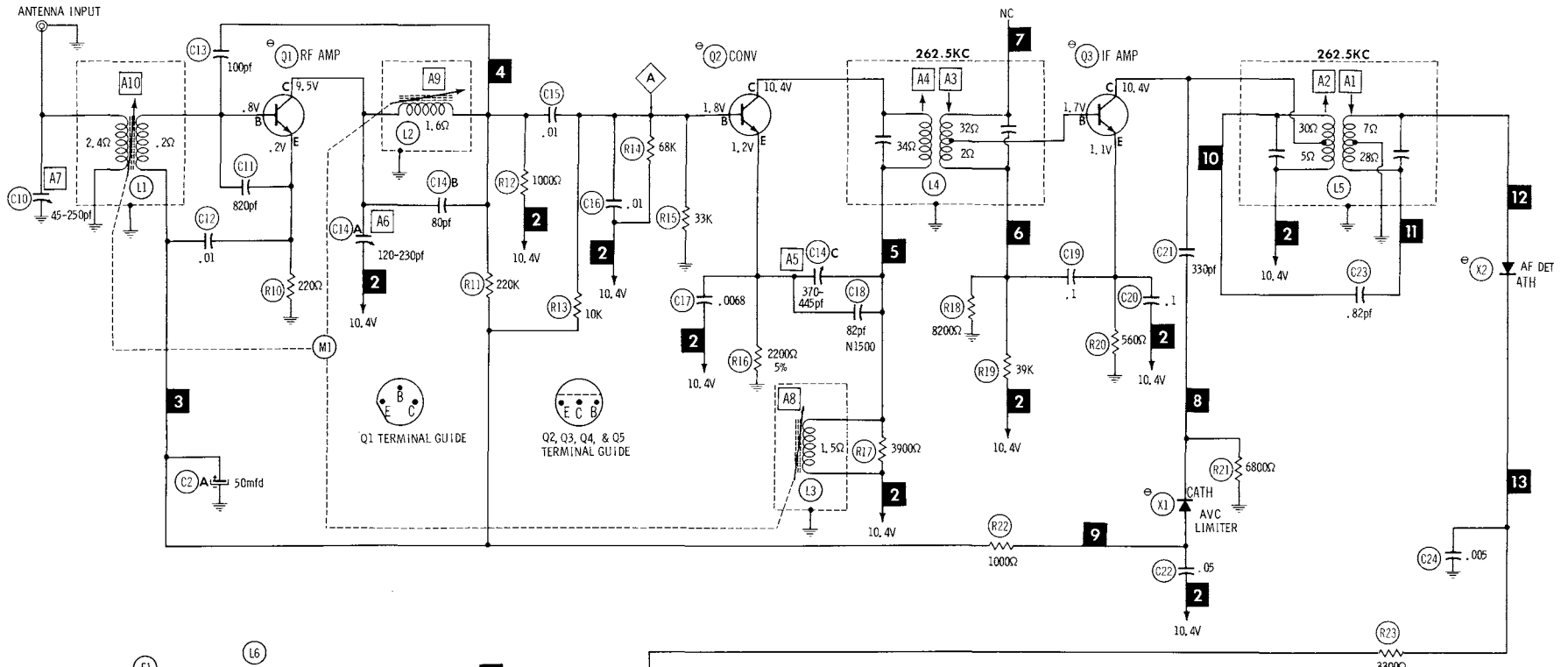

NC No Connection

★ Nominal value, may vary.

Resistors are 1/2 watt or less and rated 10% or 20% unless otherwise indicated.

⊙ See parts list

1. Voltage measurements taken with vacuum tube voltmeter.
2. All controls set for normal operation, no signal applied.
3. Measured values are from socket pin or terminal to common ground.
4. All terminals viewed from bottom unless otherwise designated.
5. Numbers assigned to terminals may not be found on the unit.
6. Supply voltage maintained at rated value for voltage readings.
7. Resistance measurements not given because of the wide variation in internal resistance of transistor.

A PHOTOFAC STANDARD NOTATION SCHEMATIC with **CIRCUITRACE**

© Howard W. Sams & Co., Inc. 1968

VOLVO MODEL 7BVOX

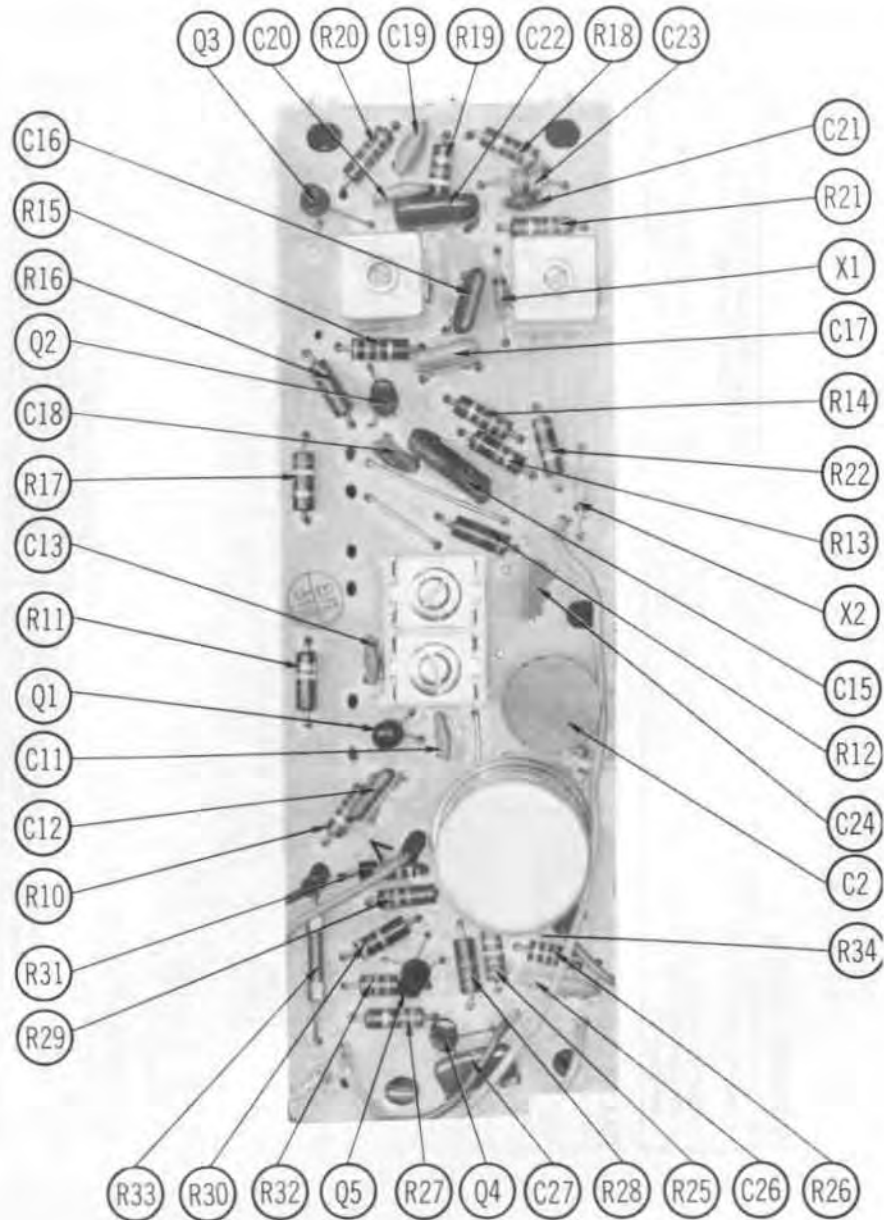
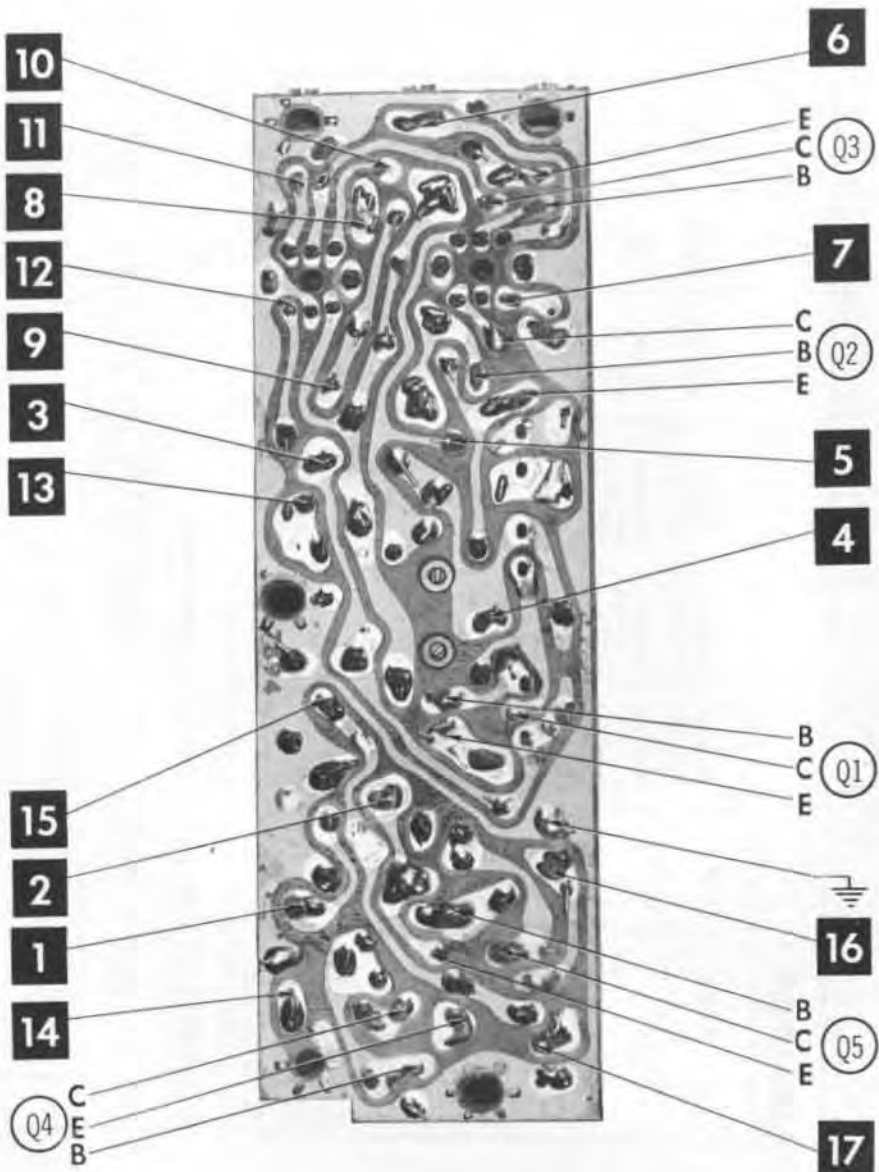

VOLVO MODEL 78V0X

PARTS LIST AND DESCRIPTION

(When ordering parts, state Model, Part Number, and Description.)

Replacement parts shown may be superseded by the availability of newly introduced replacements.
Have your local distributor check Sams COUNTER FACTS for the most up-to-date replacement.

WIRING DATA

General-use Unshielded Hook-up Wire	Use BELDEN No. 8530 (Solid) Available in 12 Colors 8524 (Stranded) Available in 12 Colors
Shielded Hook-up Wire	Use BELDEN No. 8885
Rear Seat Speaker Extension Cable	Use BELDEN No. 8782 (Stranded) Coded Parallel Leads
Bonding Strap	Use BELDEN No. 8661 (3/8 In.) or 8670 (3/4 In.)

TRANSISTORS

ITEM No.	TYPE No.	FUNCTION	REPLACEMENT DATA					
			MFGR. PART No.	DELCO PART No.	GENERAL ELECTRIC PART No.	INTERNATIONAL RECTIFIER PART No.	RCA PART No.	SYLVANIA PART No.
Q1		RF Amp	2093308-0704	DS-71	GE-20	TR-21	SK-3018	ECG 107
Q2		Converter	2093308-0705	DS-72	GE-20	TR-21	SK-3018	ECG 107
Q3		IF Amp	2093308-0706	DS-72	GE-20	TR-21	SK-3018	ECG 107
Q4		AF Amp	2092609-0718	DS-66	GE-10	TR-21	SK-3020	ECG 123
Q5		AF Amp	2057013-0702		GE-21	TR-25	SK-3025	ECG 106
Q6		Output	2057323-0501					

POWER RECTIFIERS & SIGNAL DIODES

ITEM No.	MFGR. PART OR TYPE No.	REPLACEMENT RECTIFIERS & DIODES			REPLACEMENT RECTIFIERS		NOTES
		GENERAL ELECTRIC PART No.	INTERNATIONAL RECTIFIER PART No.	SYLVANIA PART No.	RCA PART No.	SARKES TARZIAN PART No.	
X1	2092055-0001	1N34AS	1N34A	ECG 109			
X2	2092055-0001	1N34AS	1N34A	ECG 109			

ELECTROLYTIC CAPACITORS

ITEM No.	RATING	REPLACEMENT DATA						
		VOLVO PART No.	AEROVOX PART No.	CENTRALAB PART No.	CORNELL-DUBILIER PART No.	GENERAL ELECTRIC PART No.	MALLORY PART No.	SPRAGUE PART No.
C1A	900 16V	2092983-0708						PCL-2182
B	700 16V							
C2A	50 4V	2092246-0705	BCD1.5-3X1000					
B	1000 4V		50				PET295	

CAPACITORS

ITEM No.	RATING	REMARKS	REPLACEMENT DATA						
			AEROVOX PART No.	CENTRALAB PART No.	CORNELL-DUBILIER PART No.	ELMENCO PART No.	MALLORY PART No.	SPRAGUE PART No.	
C10	45-250	#2091504-0007				464			
C11	820		GPD X5F821K	DD-821	JBY601YP821K	CCD-821	GP382	10TS-T82	
C12	.01 100V		DBE6S1	CPR-10000J	DMF2S1	4DP-1-103	PVC211	2TM-S10	
C13	100		GPD X5F101K	DD-101	JBZ601YP101K	CCD-101	GP310	10TS-T10	
C14A	120-330	#2092422-0712							
B	80								
C	370-445								
C15	.01 100V		DBE6S1	CPR-10000J	DMF2S1	4DP-1-103	PVC211	2TM-S10	
C16	.01 100V		DBE6S1	CPR-10000J	DMF2S1	4DP-1-103	PVC211	2TM-S10	
C17	.0068 100V		DBE6068	CPR-6800J	DMF4068	1DP-1-682	PVC6268	225P68291	
C18	82 N1500					*	*	10TCW-Q82	
C19	.1		TTP-1	CK-104	HOV101ZV104Z		TA010	TG-P10	
C20	.1		TTP-1	CK-104	HOV101ZV104Z		TA010	TG-P10	
C21	330		GPD X5F331K	DD-331	JBZ601YP331K	CCD-331	GP333	5GA-T33	
C22	.05 25V		DBE6S5	DD-503	DPMS6S5	6DP-3-503	PVC615	6PS-S50	
C23	.82		NPO-DI 1.0	TCZ-1			CN0510	10TCC-V10	
C24	.005		GPD X5R502K	DD-502	JBT601YP502K	CCD-502	JF250	10TS-D50	
C25	.2			UK20-204	HCZ3R0XR224P		MAG12022	HY-470	
C26	.2			UK20-204	HCZ3R0XR224P		MAG12022	HY-470	
C27	.05 25V		DBE6S5	DD-503	DPMS6S5	6DP-3-503	PVC615	6PS-S50	
C28	.05 100V		DBE6S5	DD-503	DPMS6S5	6DP-3-503	PVC615	6PS-S50	
C29	.05		GPD 25V503P	DD-503	HOV101ZV503Z	CCD-503	GP150	5GA-S50	
C30	270	#2093050-0705							

Bendix Part Number.

* Not normally in distributor's stock. Available thru distributor on order to manufacturer.

CONTROLS (All wattages 1/2 watt, or less, unless listed)

ITEM No.	FUNCTION	RESISTANCE	REPLACEMENT DATA				
			MFGR. PART No.	CENTRALAB PART No.	CLAROSTAT PART No.	CTS-IRC PART No.	MALLORY PART No.
R1A	Tone	25K	2094545-0701	R2-25K, R14-25K, FFS200, RFS208, AK38, KR-7		* QJ-2199A	TF253A (P253A, SLE37) (1), RU253T53, OX1750, IS2250, US42
B	Volume/Switch	25K Tap @ 3000					
R2	Fader	80 2W	2094135-0703				

* "CONCENTRIKIT" Equivalent: K8 Kit with Base Elements and Shafts: B15-120, P17-123 (Panel), B19-119X, R26-206 (Rear),

"SNAPTROL" Equivalent: BU7, CF11, CR50T, SF14, SR50, WF R5 (Tab Mount), 76-2 (Switch)

(1) Panel and Bushing components listed in parentheses may be substituted for the panel unit.

PARTS LIST AND DESCRIPTION (CONTINUED)

(When ordering parts, state Model, Part Number, and Description.)

Replacement parts shown may be superseded by the availability of newly introduced replacements.
Have your local distributor check Sams COUNTER FACTS for the most up-to-date replacement.

RESISTORS (Power and Special)

ITEM No.	RATING	REPLACEMENT DATA			ITEM No.	RATING	REPLACEMENT DATA		
		IRC PART No.	WORKMAN PART No.	MFGR. PART No.			IRC PART No.	WORKMAN PART No.	MFGR. PART No.
R33	.8 (PTC)			2090948-0026					

COILS (RF-IF)

ITEM No.	USE	REPLACEMENT DATA			
		PART No.	MEISSNER PART No.	MILLER PART No.	WORKMAN PART No.
L1	Antenna	(1)			
L2	RF	(1)			
L3	Oscillator	(1)			
L4	Input IF	2094080-0711		8006 (2)	
L5	Output IF	2094808-0712		8006	

(1) Part of M2

(2) Cut off Pin #5

FILTER CHOKE

ITEM No.	RATINGS			REPLACEMENT DATA					NOTES
	CURRENT (Measured)	DC RES.	INDUCTANCE (0 CURRENT 1000~)	VOLVO PART No.	MERIT PART No.	STANCOR PART No.	THORDARSON PART No.	TRIAD PART No.	
L6	600ma	.6	1.5mh	2092050-0733					

TRANSFORMER (Audio Output)

ITEM No.	IMPEDANCE		REPLACEMENT DATA					NOTES
	PRI.	SEC.	MFGR. PART No.	MERIT PART No.	STANCOR PART No.	THORDARSON PART No.	TRIAD PART No.	
T1	17	8	2057317-0704					

SPEAKER

ITEM No.	TYPE			REPLACEMENT DATA			NOTES
				VOLVO PART No.	JENSEN PART No.	QUAM PART No.	
SP1	5"	PM	8 ohms	2094858-001		5A1Z8	P-1800 Rear
	5" X 7"	PM	8 ohms	2094859-0001	P5X7V8	57A15Z8	
SP2	5" X 7"	PM	8 ohms	2057765-0701	P5X7V8	57A15Z8	

FUSE DEVICES

ITEM No.	DESCRIPTION	REPLACEMENT DATA							
		PART No.		BUSS PART No.		LITTELFUSE PART No.		WORKMAN PART No.	
		DEVICE	HOLDER	DEVICE	HOLDER	DEVICE	HOLDER	DEVICE	
F1	AGA 2 Amp	2091811-0007	2094348-0526	AGA 2	HAF	301002	155004		

MISCELLANEOUS

ITEM No.	PART NAME	PART No.	NOTES
M1	Tuner	2094066-0508	CHICAGO MINIATURE Replacement CM-1892
	Coil Assembly	2090131-0094	
M2	Dial Lamp (#1892)	223198-0002	

CABINETS & CABINET PARTS (When ordering specify model, chassis & color)

ITEM	PART No.	ITEM	PART No.
Escutcheon	2094551-0505	Knob, Tuning or Volume	2091244-0002
Dial Glass	2094767-0001	Knob, Tone or Dummy	2094480-0001
Dial Pointer	2090129-0078	Knob, Fader	2091244-0002
Push Button	2056519-0001		

VOLVO MODEL 7BVOX