

VOLVO 1976

BROOKLANDS MOTOR COMPANY
MONACO HOUSE
BRISTOL STREET
BIRMINGHAM B5 7AS
Tel: 021-622 4491



VOLVO 244/245/264/265



Volvo 244 DL

The Volvo 244 DL saloon is powered by a 2.1 litre single carburettor engine with an output of 100 hp DIN. You have a choice of a four-speed manual gearbox or automatic transmission.

Like the other cars of the 240 Series, it has ergonomically designed seats, a very efficient heating and ventilation system, a triangle-split dual circuit brake system and a tight 32'2" turning circle. The 244 DL can also be ordered with a sunshine roof and power steering.

Few cars command as much world-wide respect as the Volvos of the 240 and 260 Series. To own one, is to know that you not only drive possibly the safest car on the road, but that the quality of materials and construction used in it ensure you of the best standards in modern motoring. Volvo cars have a great many features other cars lack. Examples include the immensely strong body with its energy absorbing front and rear ends and anti-intrusion members welded into each side door. They run on two-star 93 octane petrol and feature day notice lights for easier observation. To counteract rust, exposed vulnerable parts of the body are made of galvanized sheet-metal while cavities are treated with rust-proofing fluid. The bottoms of the door sills are sprayed with polyester, the brake pipes are made of copper alloy and parts of the exhaust system are aluminized. Other features which make Volvos better include the spring strut front suspension, stabilisers front and rear on saloon models, the rack and pinion steering, and power disc brakes all round. All the cars of the 240 and 260 Series come with a 12-month unlimited mileage warranty which covers both labour and parts.

You are looking at the Volvo 244 DL with cloth upholstery. The front seats have head restraints and there's plenty of room for three people in the back, while two can divide the seat with a folding armrest. The vast boot holds 21.5 cu.ft. of luggage.

Volvo 244 GL

The Volvo 244 GL gives you all the benefits of the 244 DL but with increased performance from a powerful 2.1 litre CI fuel injection engine with an output of 123 hp DIN. To go with this performance, the GL has wide, low profile radial-ply tyres, tinted glass, heated driving seat, leather faced upholstery, a special steering wheel, a tachometer, a sunshine roof, metallic paint, and the choice of a four-speed manual gearbox with overdrive, or automatic transmission. The rear window is heated electrically. Extras include power steering.





Volvo 245 DL

The Volvo 245 estate car combines passenger car comfort with van carrying capacity. With the driver and four passengers sitting comfortably, there's still 53 cubic feet of space! And with the rear seat folded down - done in two quick movements - you have a completely flat platform which is no less than 74" long and gives a cargo volume of almost 67 cubic feet. The tailgate has a wiper and washer and is heated electrically.

The Volvo 245 estate car can outmanoeuvre many smaller saloons. Turning tightly in 32'2", it is powered by a 2.1 litre single carburettor engine which has an overhead camshaft, produces an output of 100 hp DIN, and runs smoothly on two-star 93 octane petrol

Safety rearguards: the tailgate window of the Volvo 245 is electrically heated and also has a wiper and washer.



Volvo 245 DLE

For the driver who requires long-distance performance as well as carrying capacity, we have designed the 245 DLE with a 2.1 litre, CI fuel injection engine. Output is 123 hp DIN. You can choose between a four-speed manual gearbox with overdrive or automatic transmission. Tinted glass and the opulence of metallic paint are standard.

Take a closer look at the Volvo estate cars. See how easy it is to fold the rear seat and turn these extremely comfortable cars into amazingly spacious estates.

Cargo area dimensions, Volvo 245

Length, rear seat in use 44.5 in / 113 cm

Length, rear seat folded 74 in. / 188 cm.

Volume, rear seat in use approx. 53 cu.ft. / 1.5 cu.m.

Volume, rear seat folded approx. 67 cu.ft. / 1.9 cu.m.

Underfloor space approx. 2.3. cu.ft./65 cu.dm.

Two quick movements, and the rear seat is folded down to give a total cargo volume of approximately 67 cubic feet.





Volvo 264 DL

V6 light-alloy engine with overhead camshafts and a displacement of 2.7 litres. In the 264 DL this engine has a single cross-draught carburettor, contactless transistorised ignition for more accurate timing and cleaner combustion. Hot-spot heating of the induction air/fuel mixture for quicker warming up, less need of the choke and smoother running after a cold start. Output is 125 hp DIN. Four-speed manual gearbox with overdrive, or automatic transmission.

The Volvo 264 has big rectangular headlights with separate halogen bulbs for main and dipped beams giving more accurate adjustment and less tiring night driving. Engine bay and luggage compartment lighting. Automatic day running lights. Sliding steel sunroof.

The electrically operated front windows of the 264 GL are conveniently controlled from the dashboard.

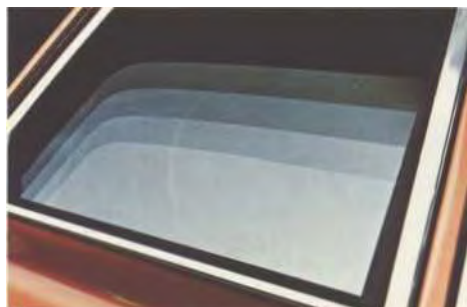

Volvo 264 GL

Volvo's finest Volvo. Seat upholstery is leather-faced. Air conditioning and electrically operated front window winders are controlled from the dashboard. Sliding steel sunroof and tinted glazing are standard. Fully carpeted boot.

The quietness of this car, the comfort it provides and the wonderful versatility of the air conditioning system make for the ultimate in motoring pleasure.

The Volvo 264 GL has a 2.7 litre engine with a fuel delivery system of Continuous Injection type. Output is not less than 140

hp DIN. Power assisted rack and pinion steering is standard.

Four-speed manual or automatic transmission. Wide, low profile steel braced radial ply tyres. Disc brakes all round, front discs ventilated.

Quality down to the smallest detail. The Volvo 264 GL comes complete with a twin stop light arrangement with separate bulbs, large area turn indicators and reversing lights as well as a high intensity rear foglight.





Volvo 265 DL

The Volvo 265 DL fulfils the most exacting demands that might be made on a modern means of practical, yet luxurious transportation.

Each element from its six-cylinder, light-alloy, overhead camshaft engine with an output of 125 hp DIN to its spacious luggage compartment, is designed for maximum efficiency.

For handling and performance the Volvo 265 DL has power assisted rack and pinion steering, steel-belted radials, and a stabilised spring strut front suspension. Beneath the eye-catching elegance of this car is a safety designed body which combines structural strength and torsional rigidity with energy absorbing crumple

zones front and rear and a safety cage surrounding the passengers.

In many ways, the Volvo 265 DL is unique. A mile-eating, up to town and down to earth car which is equally at home in the city as it is on the motorway or a winding country road. A car with fascinating capabilities.

The instrument panel is ideally laid out with all controls within convenient reach. The very comprehensive system of warning and tell tale lights includes a bulb integrity sensor and a 'fasten seat belts' reminder.

Volvo's V6. 2.7 litres, light-alloy construction. Featuring contactless ignition system, overhead camshafts and a single cross-draught carburettor.



Volvo Upholstery

Few interior materials are exposed to as much wear and tear as car upholstery. Before the Volvo engineers approve of a new material, it is very vigorously tested.

All the materials used must be fire-resistant and non-fading.

Cloth



Volvo 244 DL interior in blue cloth.



Brown



Blue



Red

Leather



Volvo 264 GL interior in brown leather.



Brown

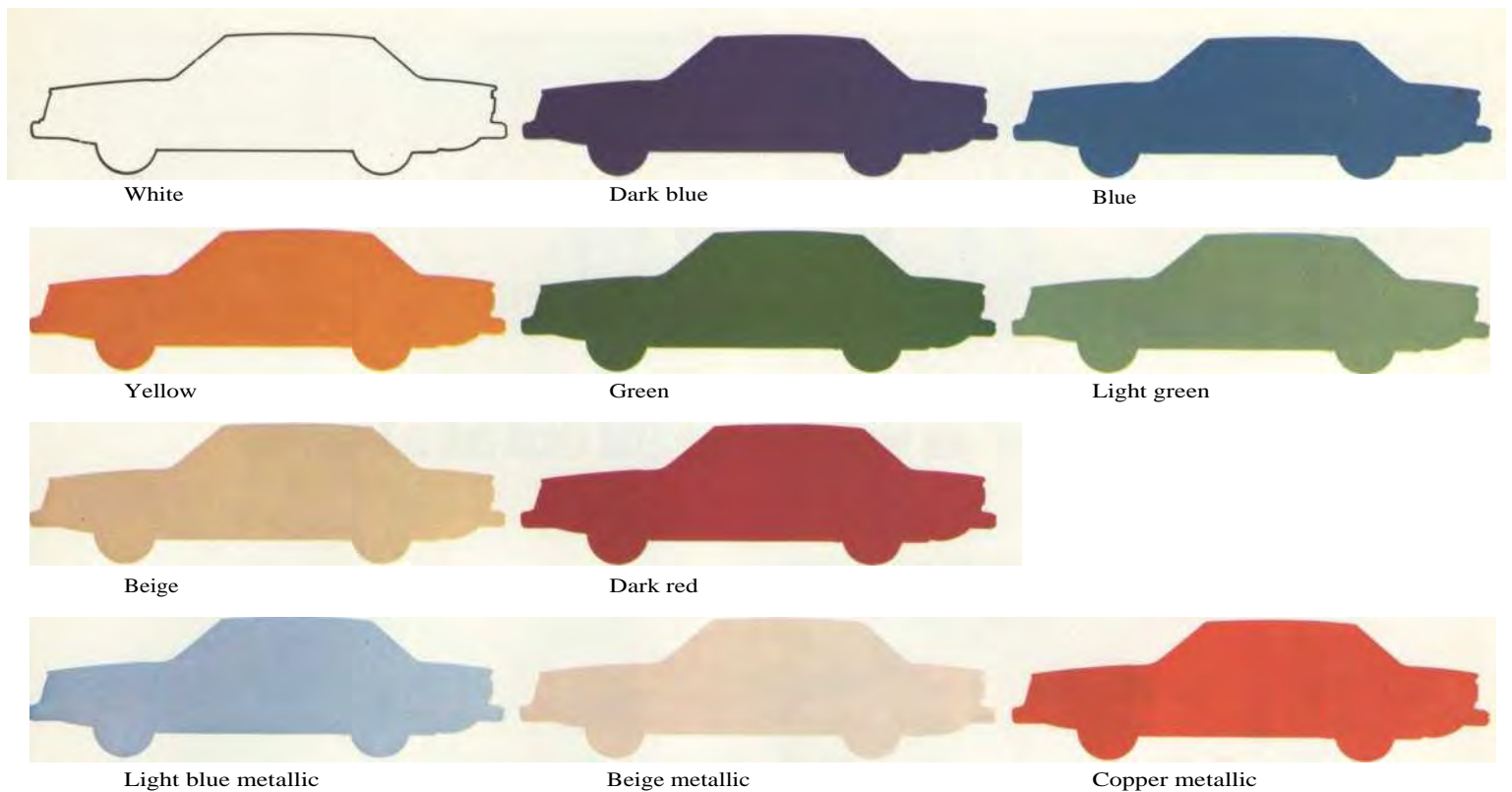

Volvo Paintwork

The gleam of Volvo paintwork is not just attractive to the eye. It is also an important part of the thorough rustproofing. Before the body is painted, it is sprayed with a zinc phosphate solution which etches the metal to protect it from rust and to provide better adhesion for the paint, the first coating of which is electrolytically applied in a paint

bath to ensure that all parts of the car, including cavities, are given an even coating.

Rustproofing paint is sprayed into the door sills which are cavity ventilated to counteract corrosion and their lower sides are coated with polyester for the same reason. Then the entire body is sprayed with a special paint to smooth out any

irregularities. After careful inspection, sealing, insulation, rubbing-down, washing and a good clean, the body is ready for the top coatings. All of the outside surfaces are meticulously coated, wet-on-wet. As you can see, there's much more behind the mirror finish of your new Volvo.

Colour and Upholstery combinations	Volvo 244 DL	Volvo 245 DL	Volvo 245 DLE	Volvo 244 GL	Volvo 264 DL	Volvo 265 DL	Volvo 264 GL
	Cloth	Cloth	Cloth	Leather	Cloth	Cloth	Leather
White	Red	Red			Red		
Dark blue	Blue	Blue			Blue		Brown
Blue	Blue	Blue			Blue	Blue	
Yellow	Brown	Brown			Brown	Brown	
Green	Brown	Brown			Brown		
Light green	Brown	Brown			Brown		
Beige	Brown	Brown			Brown		
Dark red	Red	Red			Red	Red	Brown
Light blue metallic			Blue	Brown		Blue	Brown
Beige metallic			Brown	Brown		Brown	Brown
Copper metallic			Brown	Brown		Brown	Brown

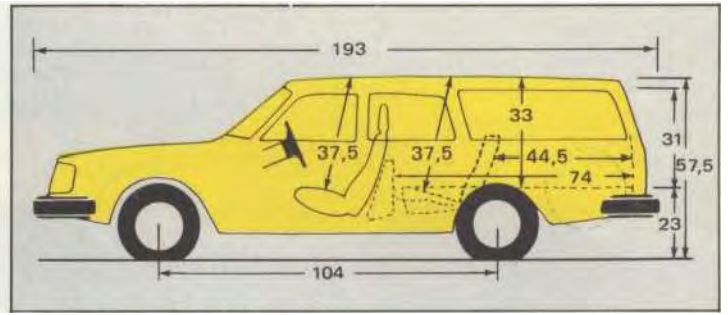
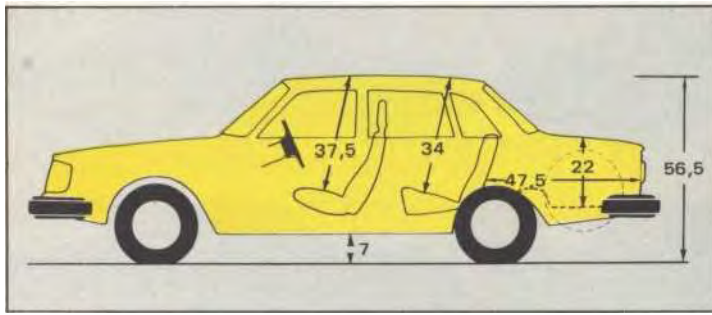

Can you name a car as well thought out as a Volvo ?

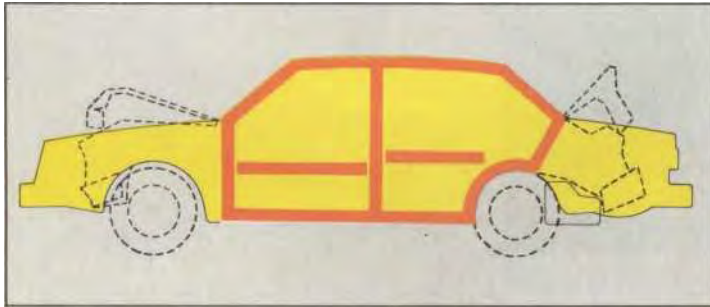

The front and rear sections of a Volvo are crumple zones to absorb crash impact. The driver and passengers travel in an immensely strong safety cage. To protect against side swipes, each of the doors incorporates an anti-intrusion member.

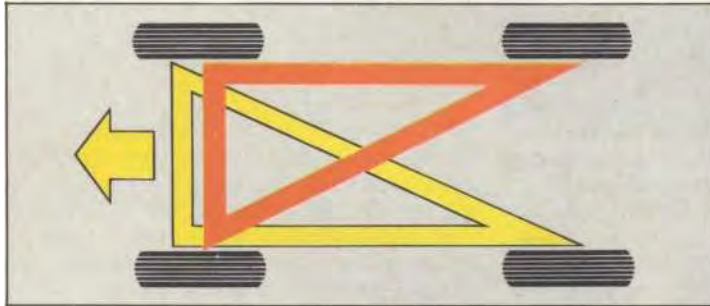

Behind each wheel is a disc brake. Fed by a triangle-split, dual circuit system. Should one of these circuits fail completely, the other will still give about 80 % of full braking power. And thanks to the stepped-bore master cylinder, this is achieved without any appreciable change in brake pedal travel or the load applied. Special relief valves prevent the rear wheels from locking up prematurely in the case of emergency braking.

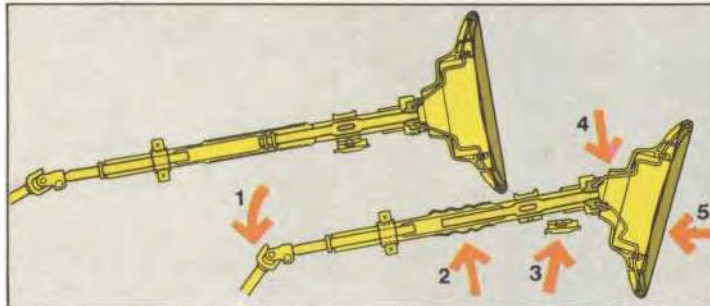

Volvo steering gives fivefold safety in the event of a collision:
 1) The lower steering rods folds downwards; 2) The steering sleeve telescopes downwards; 3) The steering rod slides forwards away from the driver; 4) The wheel's anchorage to the column crumples, and 5) the wide bolstered hub spreads the impact.

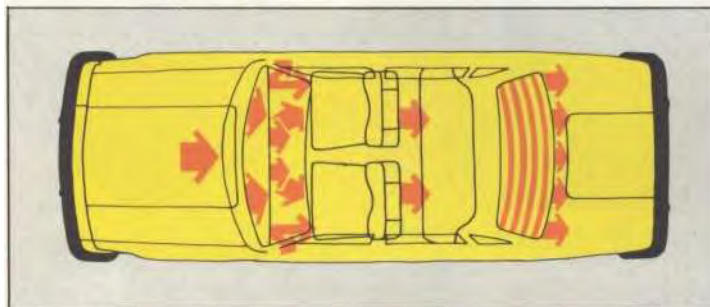

Efficient and with plenty of capacity, the heating and ventilation system blows warm or cool air through twelve strategically located entry points. The flow and aim of the air is quickly and conveniently adjusted and the back seat passengers are also well catered for by nozzles mounted beneath the front seats. The degree of heat is thermostatically controlled and the booster fan has three speeds. Stale air is exhausted through the exhaust vents below the window in the saloon cars and on the right-hand rear wing of the estate car.

VOLVO

AB Volvo, Car Division, Goteborg, Sweden

The factory reserves the right to make changes at any time, without notice, to prices, colours, materials, equipment, specifications and models and also to discontinue models.

RSP/PV 2750/2-76. Engelska. Printed in Great Britain.